

ROZWIĄZANIA RUNDA II

2.1

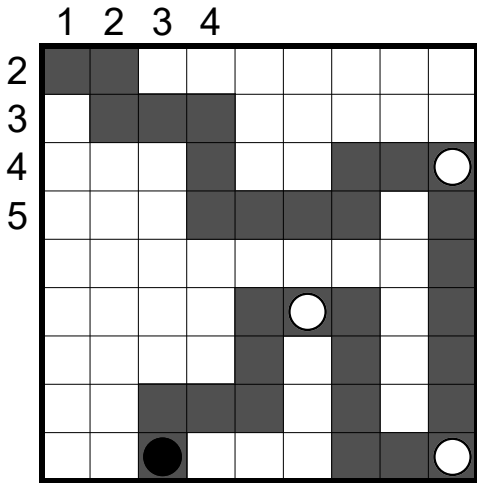

2.2

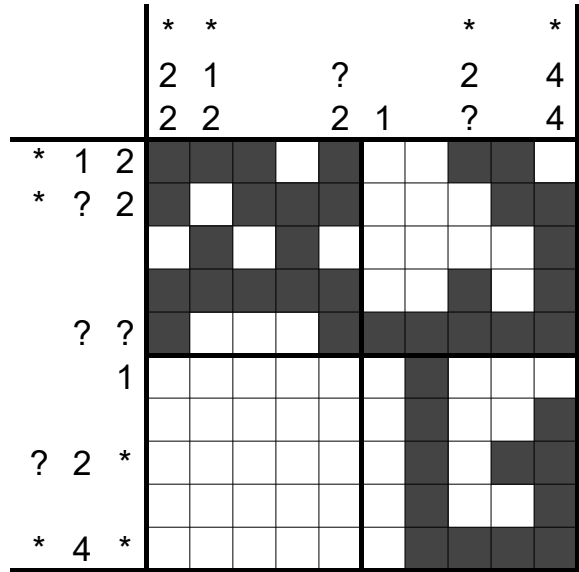

2.3

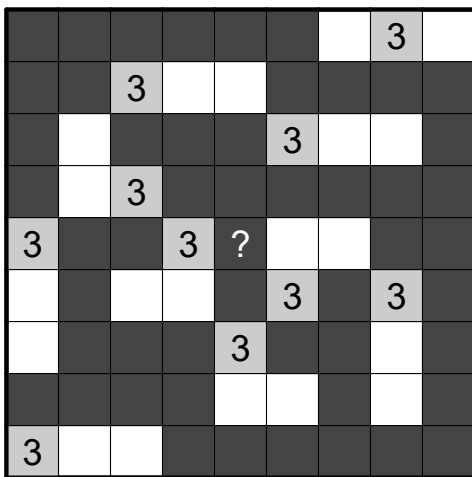

2.4

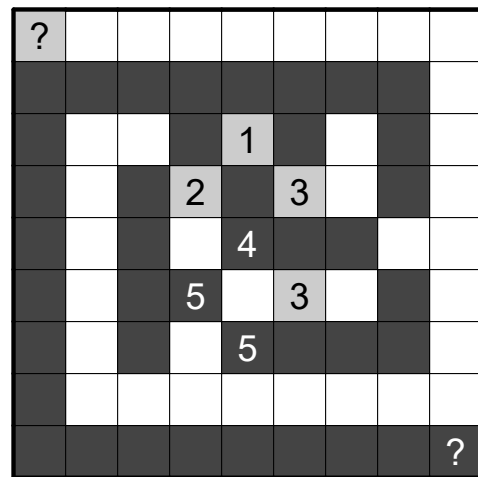

2.5

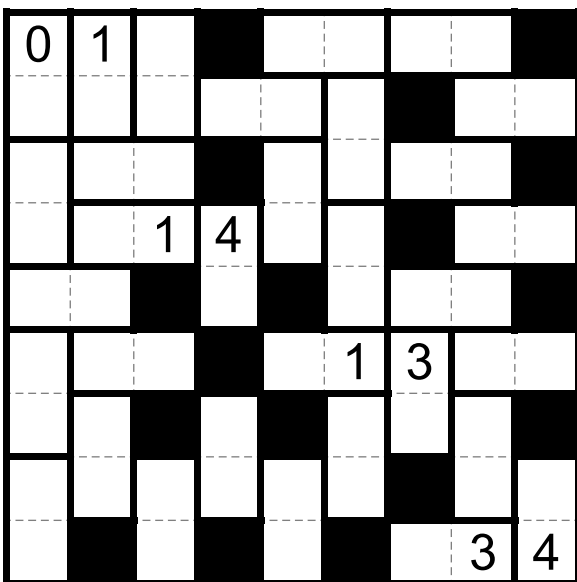

2.6

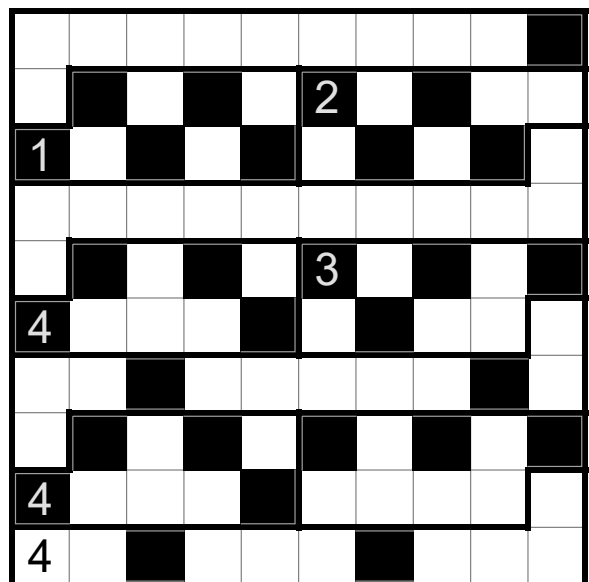

ROZWIĄZANIA RUNDA II

2.7

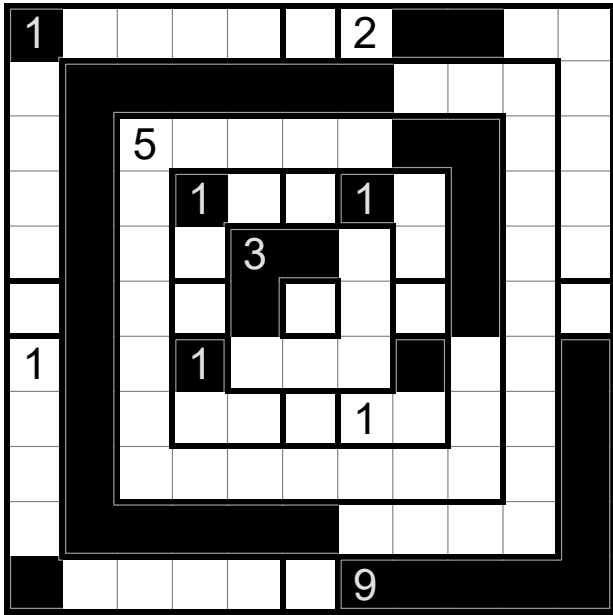

2.8

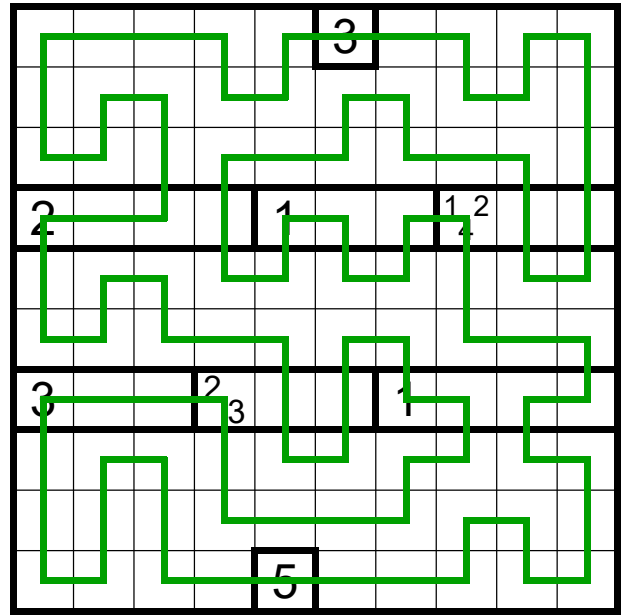

2.9

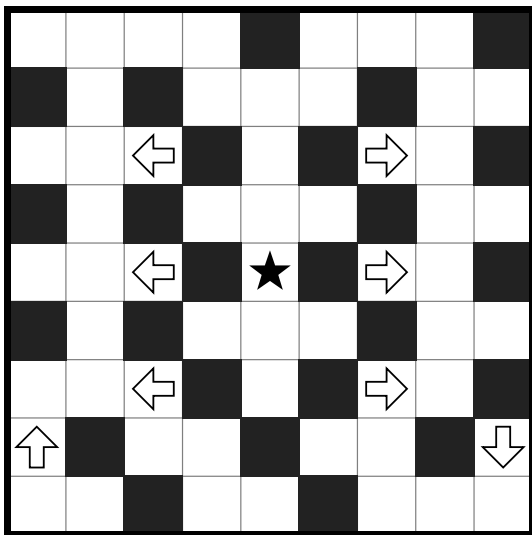

2.10

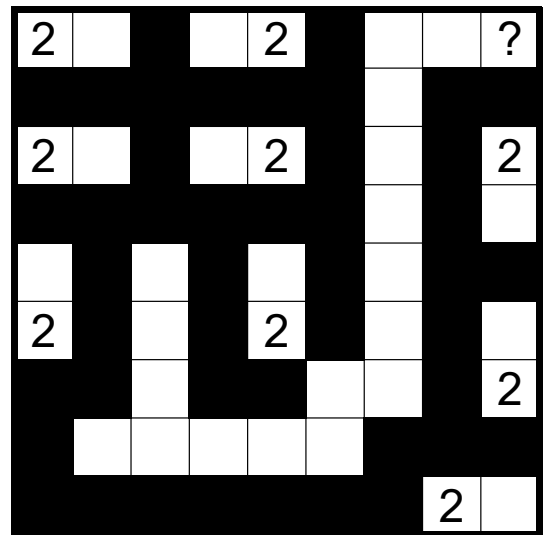

2.11

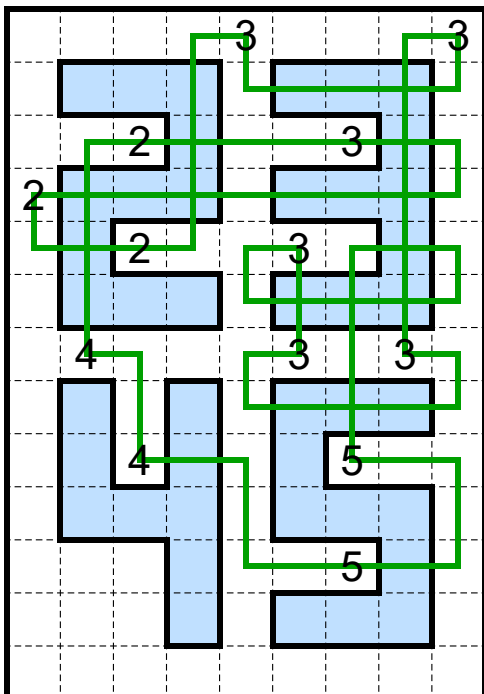

2.12

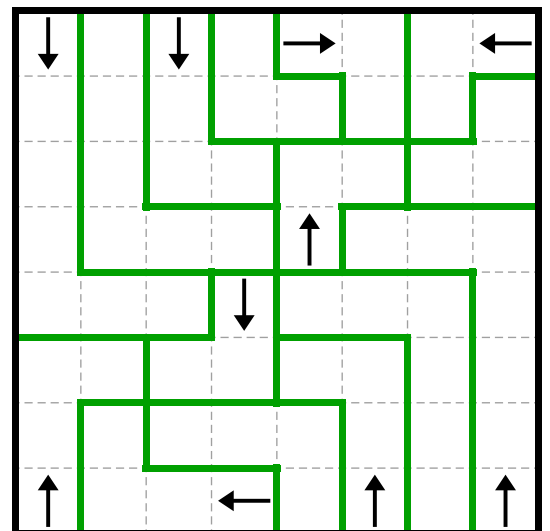

ROZWIĄZANIA RUNDA II

2.13

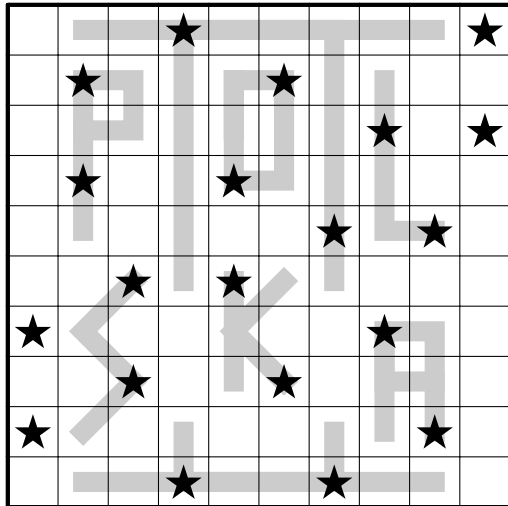

2.14

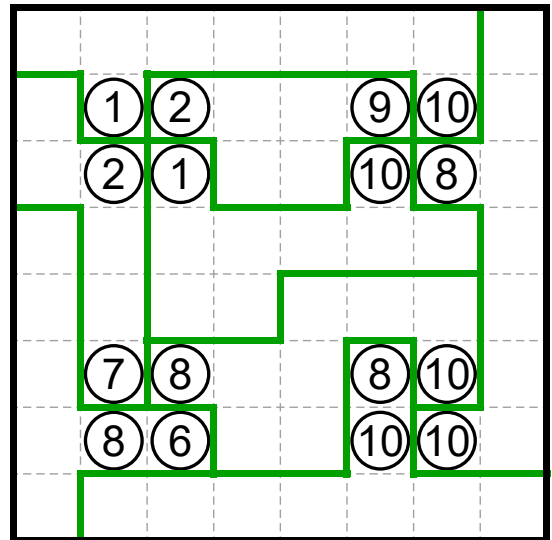

2.15

